

CONVEYING

Conveying technology – Lifeline of body-in-white automation

Viewed from above the conveying lines of a production layout appear to be the lifelines of an automation organism, pulsing to the beat of the single robot cells.

Put into simple terms, the task of conveying systems is the transport of parts from A to B. With a view to the highly automated production plants in car body manufacture, conveying systems are not just the connecting links, but also serve as intelligent buffer segments which decouple the individual processes, thereby adding to flexibility.

As a “lifeline” within the process chain, conveying technology is a crucial factor for availability. The failure of just one segment has direct consequences for the overall process. This is another reason why robustness and a high level of availability are the most important criteria when it comes to designing TÜNKERS conveying technology.

The increasing flexibilisation of body assembly lines creates new challenges for conveying technology. The myriad of parts required results in aisles overloaded with conveyor belts, consuming more and more space in the plant layout. One solution is provided by vertical chain conveyors, or paternosters used to buffer parts vertically.

The APM Dragon Khan conveyor is a completely new development. It uses distributing stations to straighten out the logistics concept within the lines by supplying them over central stations. In some areas, the TÜNKERS Dragon Khan conveyor now includes functions that have so far only been performed by complex electric overhead tracks.

The current TÜNKERS range of products offers you a tailored solution for almost any application of conveying technology in body-in-white assembly and also for adjacent production lines such as the power train and the final assembly.

Product range:

1. Accumulating conveyor systems

Conveyor systems in which the component pallet is moved uncoupled from the drive chain. The components may be unloaded irrespective of the loading cycle as long as the accumulating line is filled. Technically speaking, we differentiate between conventional accumulating conveyors with drive chain and accumulating belt conveyors for more lightweight applications. Typical applications include the connection of production cells.

2. Indexing chain conveyors

The pallets or component carriers are fixed to the drive chain or belt. Loading and unloading in a defined indexed cycle. When the loading or unloading station stops, the entire parts flow is interrupted.

3. Container systems

In contrast to the pallet systems mentioned above, the components are transported in containers here. Usually, they have a higher weight and standardized containers, e.g. to suit euro pallets. Typical applications include adding and replacing containers in the robotic cells.

4. Conveyor systems

Conveyor systems across cells using proven TÜNKERS modules such as accumulating conveyors, buffer systems and lifts. Construction of complex lines, preferably as overhead track systems which supplement the superordinate conveying technology with material logistics and open up ways to create independent loading and transporting lines in the layout.

Our personnel at TÜNKERS, TÜNKERS-Iberica APM and our international sales team are happy to assist you with the dimensioning and technical design of your conveyor requirements. Just get in touch with us.

Your TÜNKERS conveying technology team

Construction guidelines

Accumulating conveyor AFS system

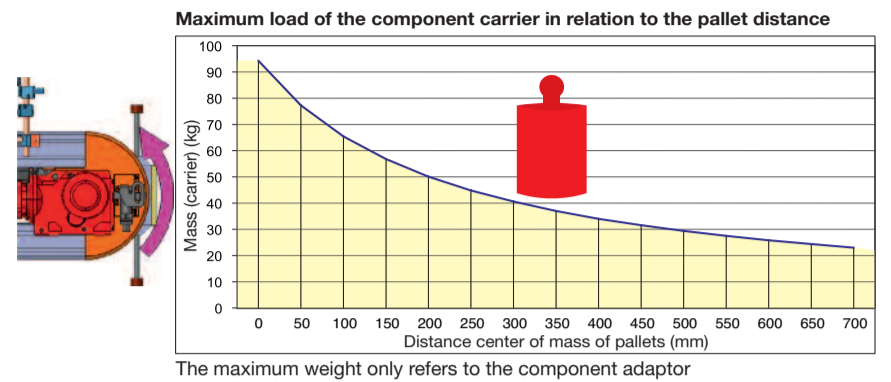

Accumulating conveyor AFS 90° system

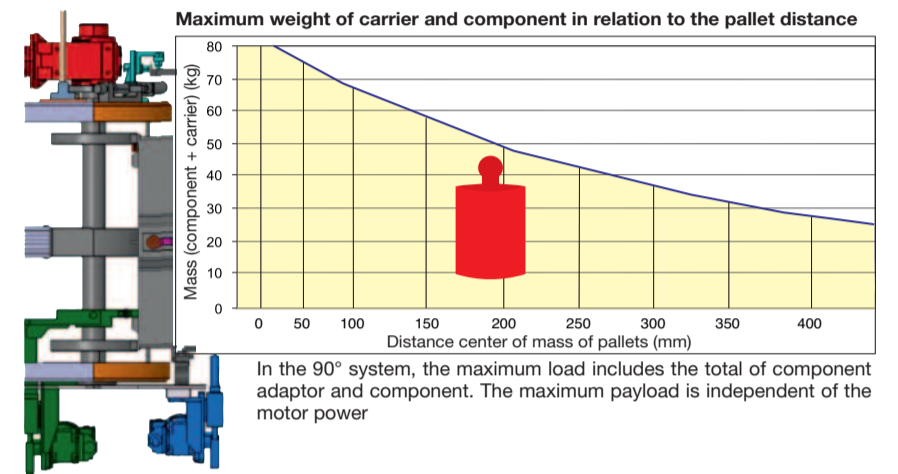

Accumulating belt conveyor LFS system

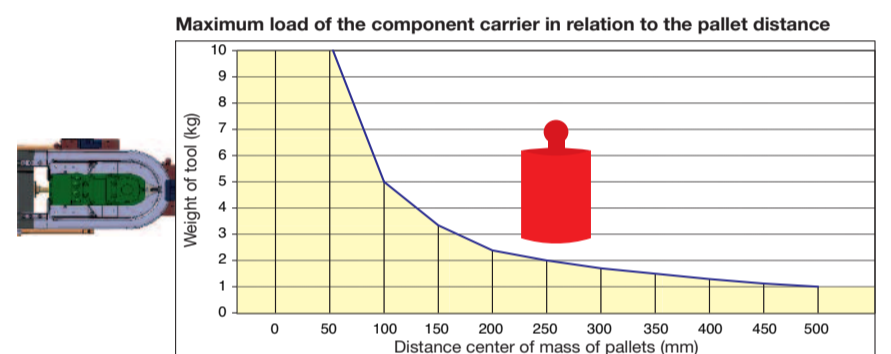

Accumulating belt conveyor LFS 90° system

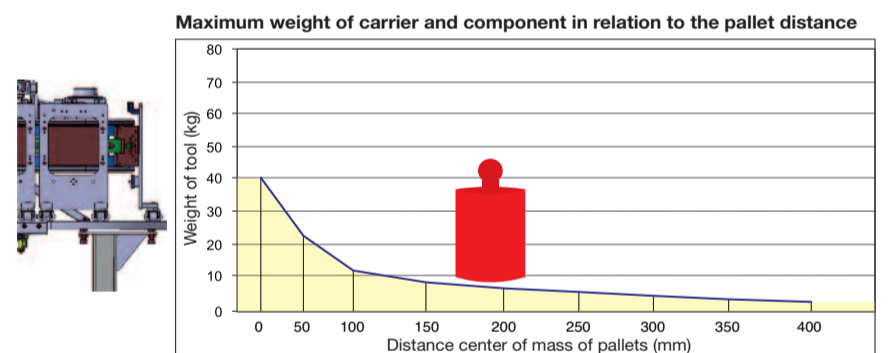

Indexing chain conveyor AFT system

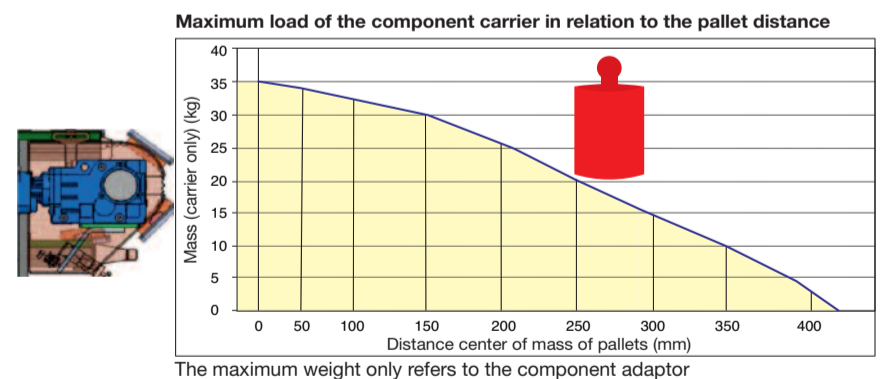

Indexing chain conveyor AFT 90° system

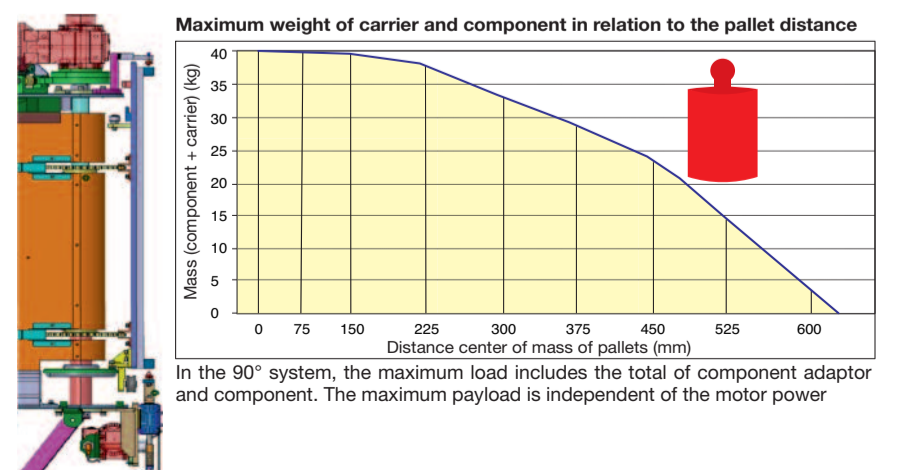

CONVEYING

Accumulating conveyor

AFS pallet accumulating conveyor

- Robust pallet conveyor with chain drive
- Max. pallet load (component + carrier) 130 kg
- Suitable for medium and large components up to about 3,000 mm width
- Stop option at turning point
- Fully electric control as an option

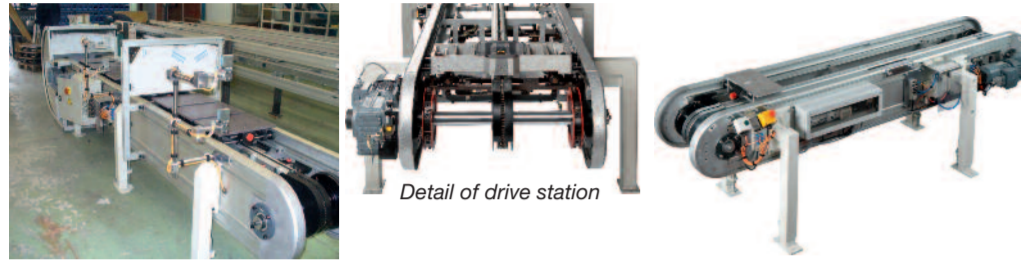

Detail of drive station

AFS 90° pallet accumulating conveyor

- 90° lateral conveyor for space-saving transport
- No protective casing required as pallet drive only in function
- Stop in the bend of 0-180°
- Complete pallet support in Z with additional guide rail

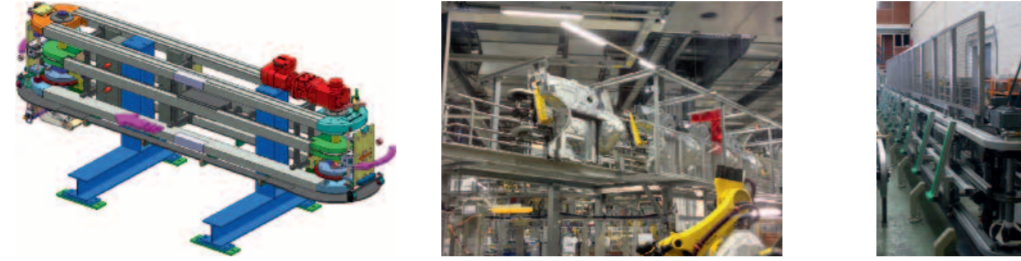

Lateral transport conveyor

End position station

Detail of drive station

- Pallet guidance over a simple roller conveyor
- No drive
- Little floor space required
- Lightweight, modular framework construction
- Precise end position lock with Tünkers clamping technology

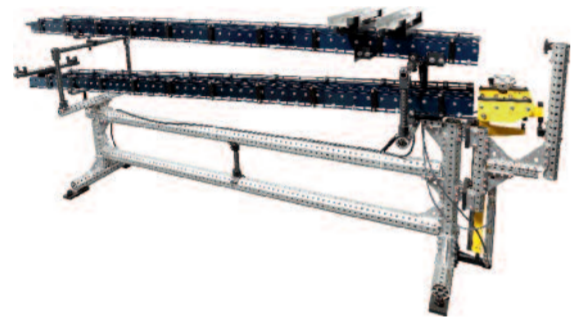

LFS pallet belt conveyor

- Compact pallet conveyor with belt drive
- Max. pallet load (component + carrier) 60 kg
- Suitable for small to medium parts up to a width of 1,500 mm
- Standard worker protection as no form closure between line and pallet
- Loading from the front possible as no protective casing required



Indexing chain conveyors

AFTV/AFP vertical chain conveyors

- Pallet transport over simple roller conveyor
- Chain conveyor in upright design
- Robust base frame in welded steel construction
- Max. component width 2,000 mm
- Max. component weight 10 kg
- Option: paternoster system with component carrier in swinging "gondola design"

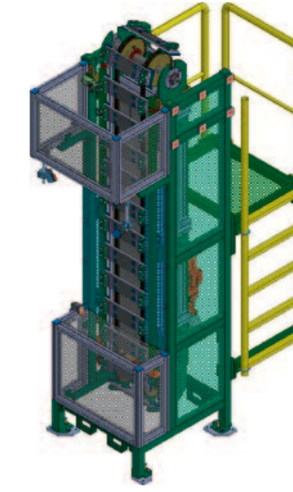

Vertical conveyor with frontal pallet positioning

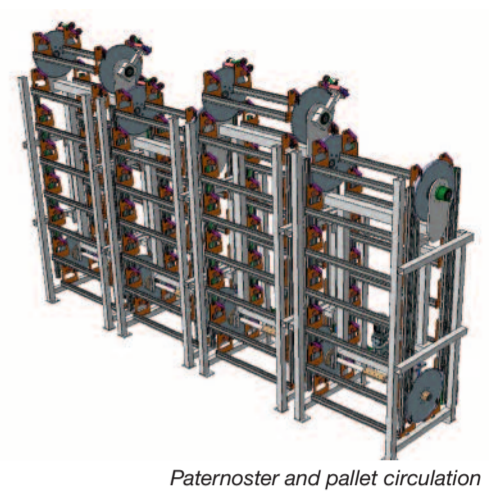

Paternoster and pallet circulation

ATS Transfer system

- Quick component transport at 2 m/sec. over distances of 10-30 m
- Compact carrier with component products up to 250 kg
- Drive with low-wear belt drive
- Fine positioning with locking unit in end positions

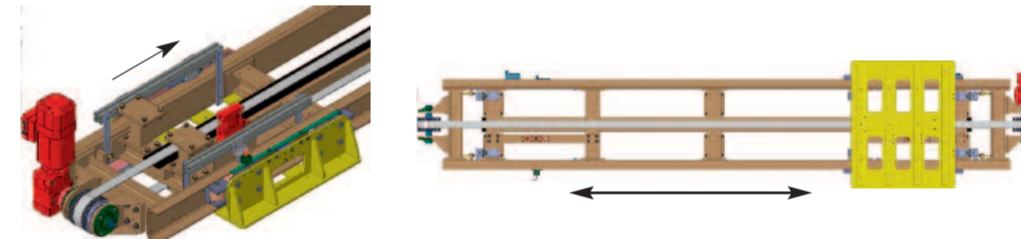

EFG belt conveyor

- Robust base frame in steel plate design
- Free loading and unloading space due to underfloor drive unit
- Max. belt width ca. 2,000 mm
- Max. component length ca. 20 m
- Optional dual belt for special component geometries



Inclined conveyor belt for front hood conveying

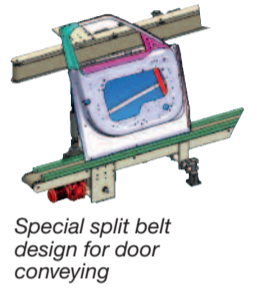

Special split belt design for door conveying

Container systems

Container rotating system

- Simple and flat solution for loading and unloading of containers
- External motor optimizes height and access for maintenance
- Optional ram protection, position pin for loading/unloading
- Diameter 3-6 m
- Payload up to 6,000 kg

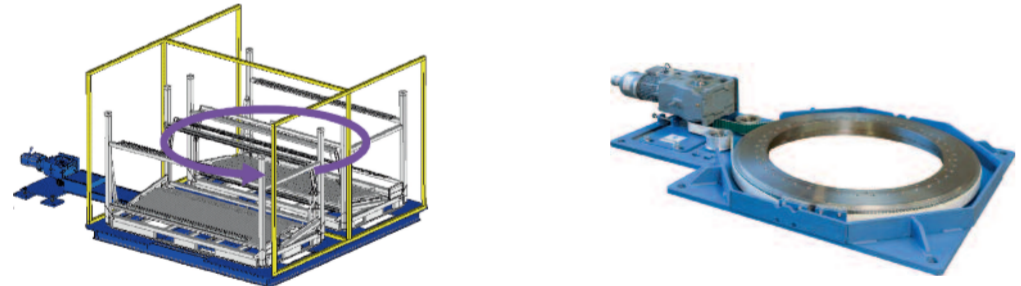

Heavy-load roller conveyor

- Roller conveyor for loads up to 1000 kg
- Roller drive over central chain
- One motor concept
- Each roll has a power/free function with a separate right coupling/function
- Roller conveyor line for transport container

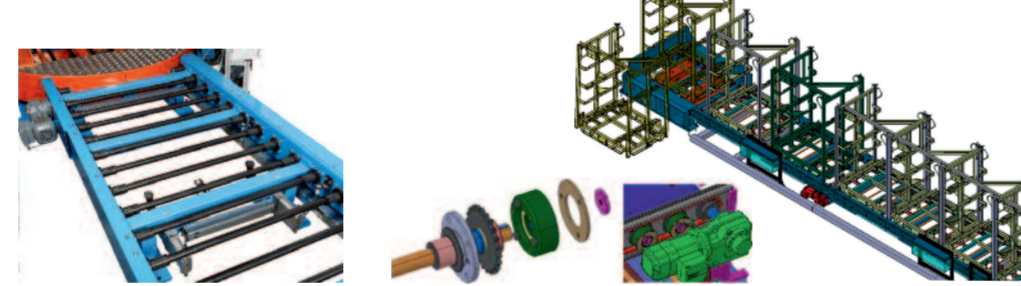

BWS container changing system

- Changing system for containers for loading by forklifts and component withdrawal by robots
- 3 containers each in operation
- Integrated lifter for changing function

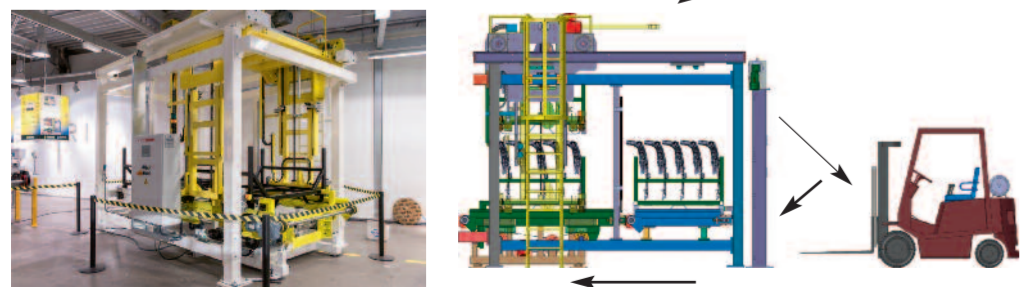

Gravity container conveyor

- Container transport without drive
- Simple transport with roller floor / gravity principle
- Base with superstructure to be assembled
- Integrated return transport

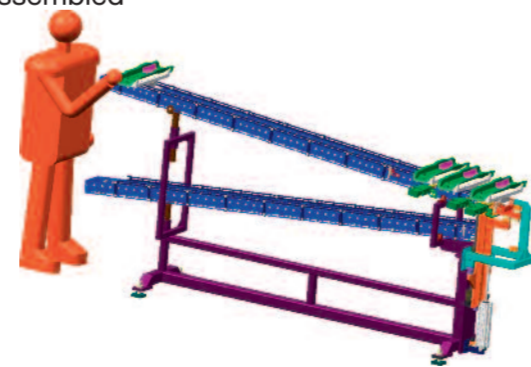

Dragon Khan conveyor system

DKN conveyor system

- Accumulating conveyor system with overhead rail concept
- Individual belt lengths with one drive up to 25 m, coupled systems up to 250 m
- Component pallets for loads up to 80 kg
- Lifts and vertical add-on parts for expansion to complex conveyor belt lengths

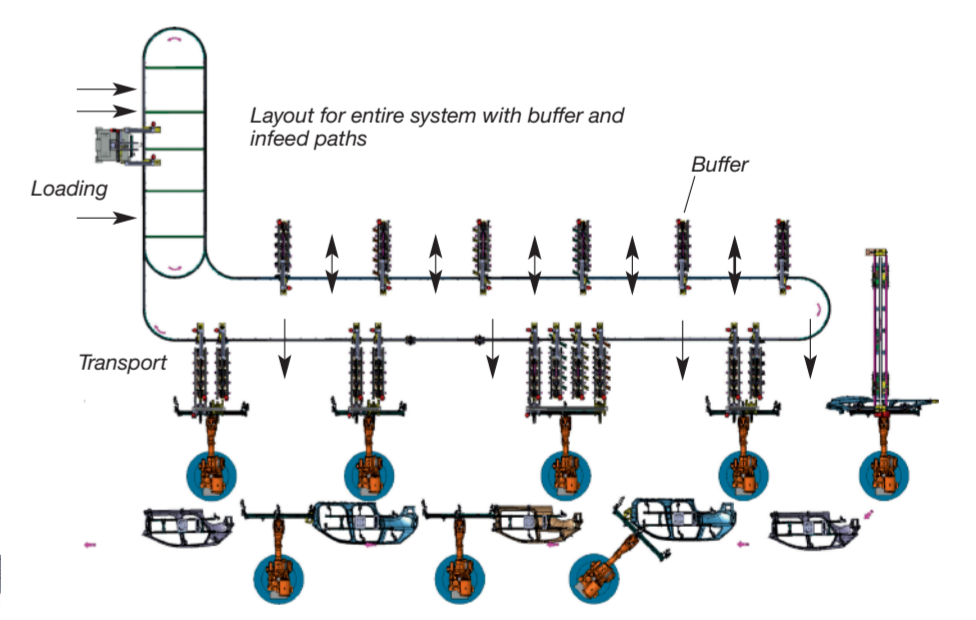
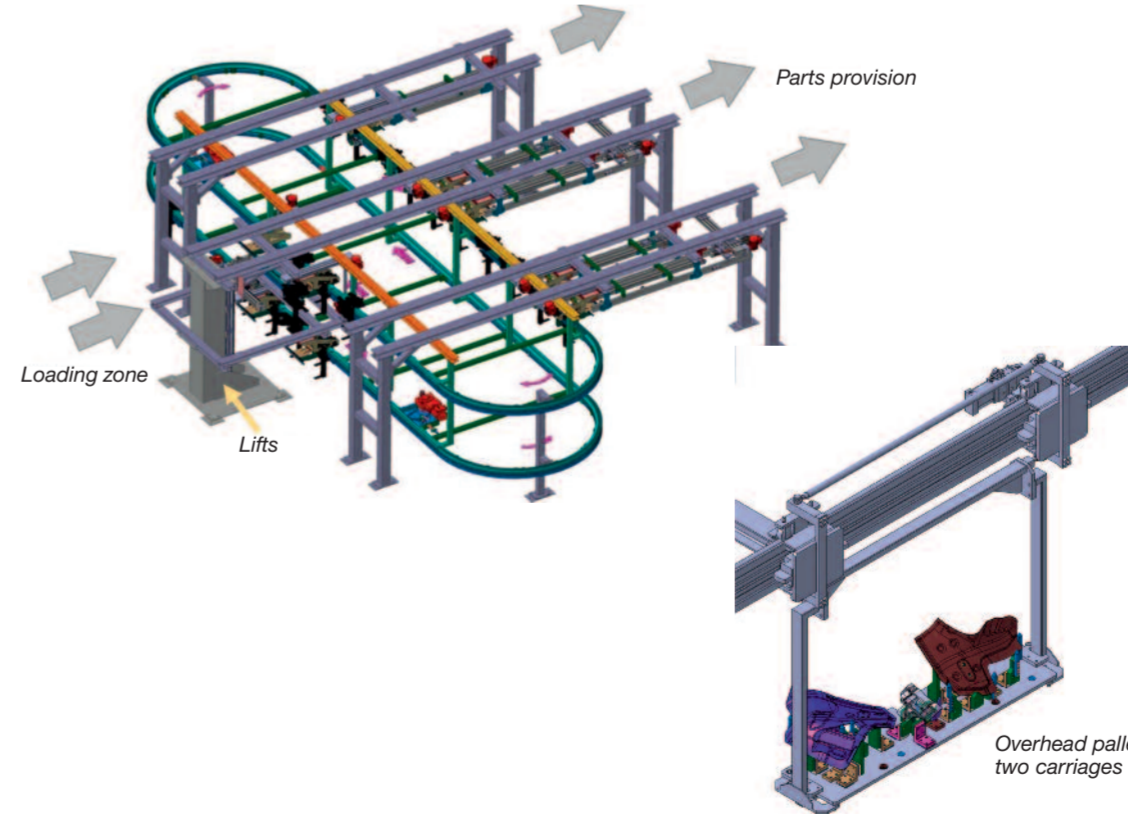

Detail of distributing station for 3 component types

